



Electrolux
PROFESSIONAL

Stainless Steel Preparation 373x950 mm Aluminum Linear Units

ITEM # _____

MODEL # _____

NAME # _____

SIS # _____

AIA # _____



137012 (ALS950)

Linear Shelving Set with
aluminium side uprights and
4 polyethylene louvered
shelves, 373x950 mm

Short Form Specification

Item No. _____

For linear installation. 4-level shelving set with louvered sectional polyethylene shelves (depth=373mm). Aluminium (20 micron) side uprights (height=1700mm). Adjustable feet.

Main Features

- Complete shelving system allows rapid and easy fixing of the shelves to the uprights.
- GN 1/1, GN 1/2 and GN 1/3 can be inserted into the frame.

Construction

- Uprights and shelf frames constructed entirely in anodized aluminium (20 micron).
- 4 tiers.
- Shelves made by section of polyethylene tablets.
- Sectional polyethylene shelves are dishwasher safe.

Optional Accessories

- Polyethylene shelf with aluminium frame, 373x886mm PNC 850039
- Angle joint for shelves (depth=373mm) PNC 850070
- 2 swivelling wheels, 100mm PNC 850072
- 2 swivelling wheels with brakes, 100mm PNC 850073

APPROVAL: _____



Experience the Excellence
www.electroluxprofessional.com

Front

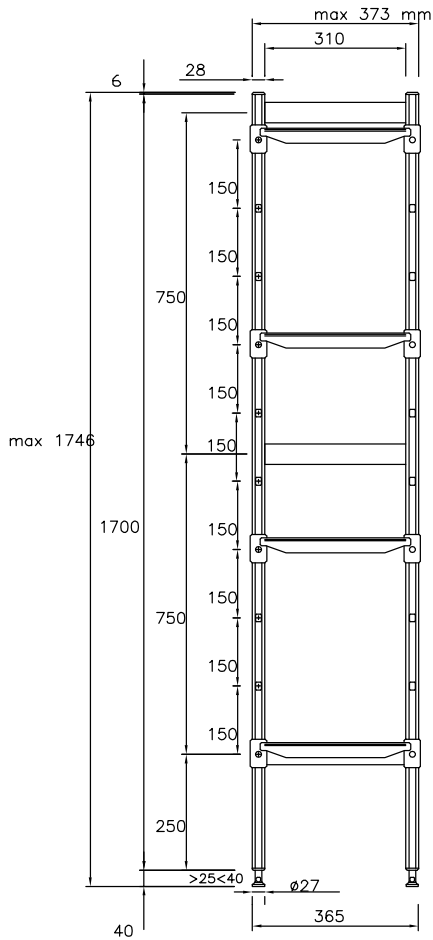

Top

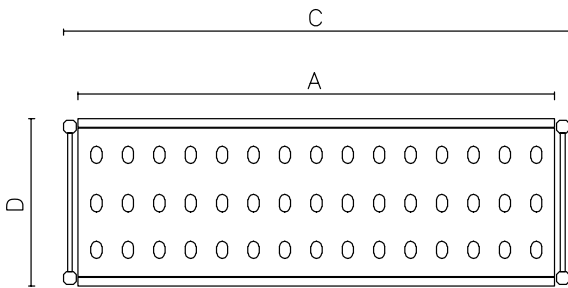

Other

	A mm	C mm	D mm
137010	708	772	373
137011	798	862	373
137012	886	950	373
137013	974	1038	373
137014	1062	1126	373
137015	1152	1216	373
137016	1240	1304	373
137017	1330	1394	373
137018	1505	1569	373

Key Information:
External dimensions, Width:

137012 (ALS950) 950 mm

External dimensions, Depth: 373 mm

External dimensions, Height: 1700 mm

Max loading weight: 880 kg

Net weight: 18 kg

Uprights: 2